



### DESCRIPTION

The PT8000 is a stainless steel bending beam loadcell with a hermetically sealed welded construction to IP-68 standard. This uniquely designed sensor allows for superior bellows operation through its full measurement cycle, providing better lifelong protection and accuracy.

Design benefits can be seen clearly with a less than 0.4mm deflection at full load and a safe loading rating of 150% of the rated capacity with an ultimate load rating of 300%.

In addition to its compact footprint (common to all eight capacities from 5kg to 500kg), this loadcell has a superbly designed mounting accessory selection to optimise the performance and life of the loadcell.

The PT8000 is an ideal selection for most industrial applications with special advantages in wash down and harsh environments. Individually packaged and supplied with serial number traceable accuracy certificate, the PT8000 is covered by a three-year warranty.

### APPLICATIONS

- Weighing and Packing Machines
- Mechanical Scale Conversions
- Food, Marine and Other Wash Down Environments

### FEATURES

- Welded Stainless Steel Enclosure
- Industry Standard Size and Shape
- Large Capacity Range 5kg to 500kg
- Comprehensive Mounting Accessory Packages



### TECHNICAL DATA

Signal Output at Capacity	2mV/V ±0.1%
Linearity Error	<0.020% FSO
Non-Repeatability	<0.010% FSO
Combined Error	<0.025% FSO
Hysteresis	<0.020% FSO
Creep/Zero Return (30 Minutes)	<0.025%/0.017% FSO
Zero Balance	<1% Capacity
Temperature Effect on Span (/10°C)	<0.010% FSO
Temperature Effect on Zero (/10°C)	<0.015% FSO
Operating Temperature Range	-30°C to +80°C
Compensated Temperature Range	-10°C to +40°C

Service Load	100% Capacity
Safe Load	150% Capacity
Ultimate Load	300% Capacity
Input Resistance	415Ω ±15Ω
Output Resistance	350Ω ±3Ω
Insulation Resistance	>5,000MΩ @ 100VDC
Excitation Voltage (Recommended)	5V to 12V AC/DC
Excitation Voltage (Maximum)	15V AC/DC
Deflection at Capacity	<0.4mm
Material	Stainless Steel
Finish	Electroless Nickel Plated
Net Weight	0.45kg
Sealing	IP-678

# DIMENSIONS

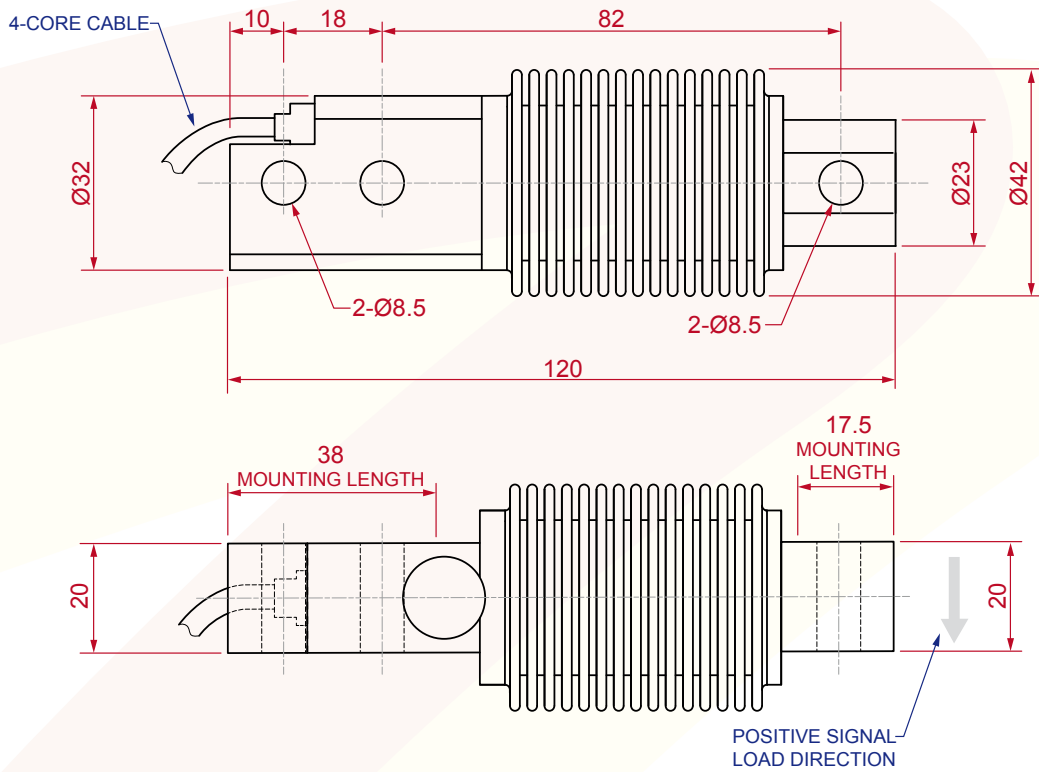

# CABLE

COLOUR	DESIGNATION
Red	+ Excitation
Black	- Excitation
Green	+ Signal
White	- Signal

Type: 4.5mm, Screened, PUR Sheath, 4-Core, 0.24mm<sup>2</sup> (24 AWG)

Length: 3m

# MOUNTING ACCESSORIES

Standard Free Motion Mount

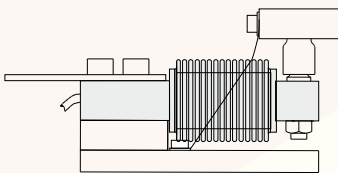

Restraining Free Motion Mount

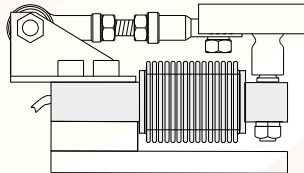

Suspension Free Motion Mount  
(Male or female options available)

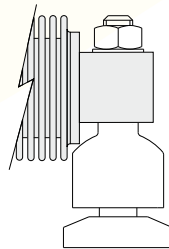
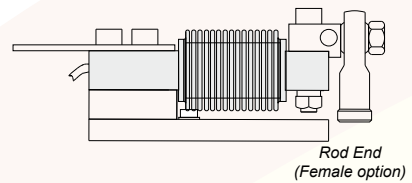

Swivel Foot

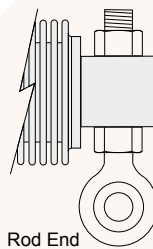

Rod End

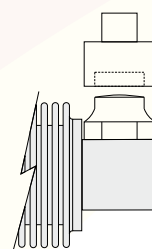

Load Socket  
Load Button

Accuweigh Pty Ltd

WESTERN AUSTRALIA (HEAD OFFICE):  
PHONE: (08) 9259 5535

SOUTH AUSTRALIA OFFICE:  
PHONE: (08) 8447 5011

NEW SOUTH WALES (SYDNEY) OFFICE:  
PHONE: (02) 9728 4877



[www.accuweigh.com.au](http://www.accuweigh.com.au)

VICTORIA OFFICE:  
PHONE: (03) 9548 5554

NEW SOUTH WALES (NEWCASTLE) OFFICE:  
PHONE: (02) 4966 8900

QUEENSLAND OFFICE:  
PHONE: (07) 3265 5520